

Codice: SEI CC 1200 AG

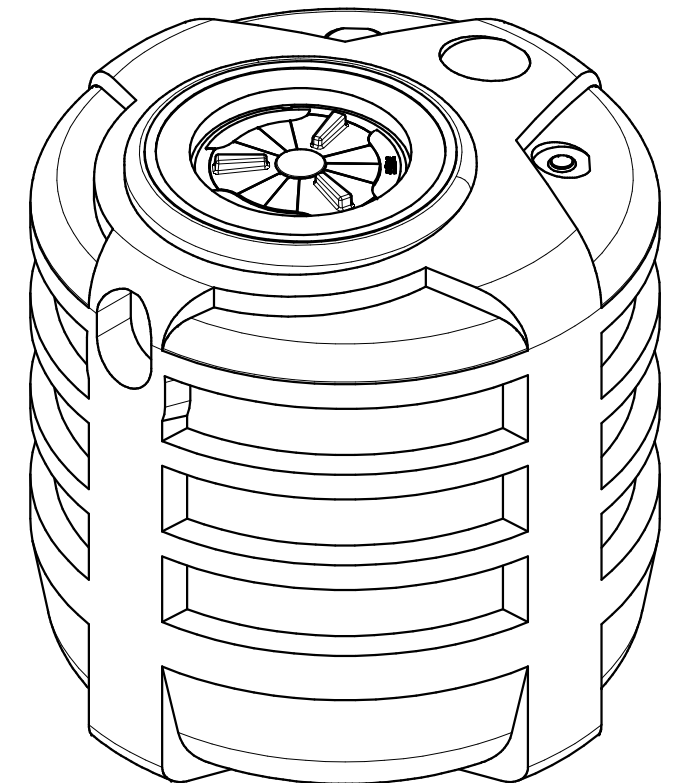
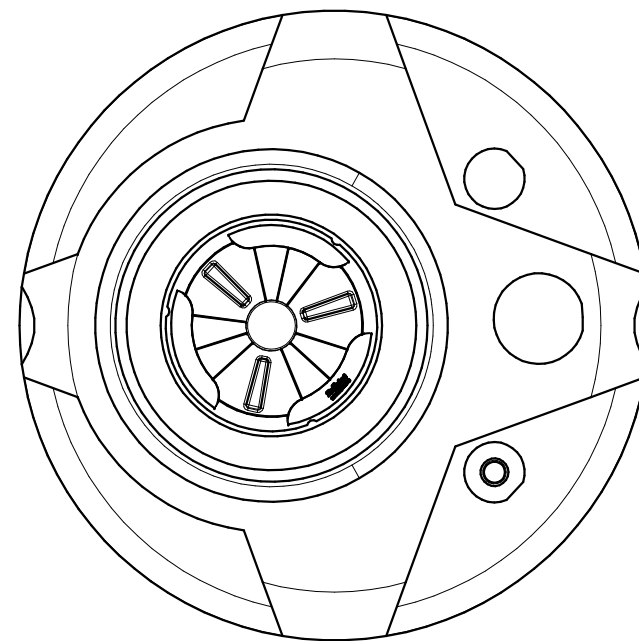
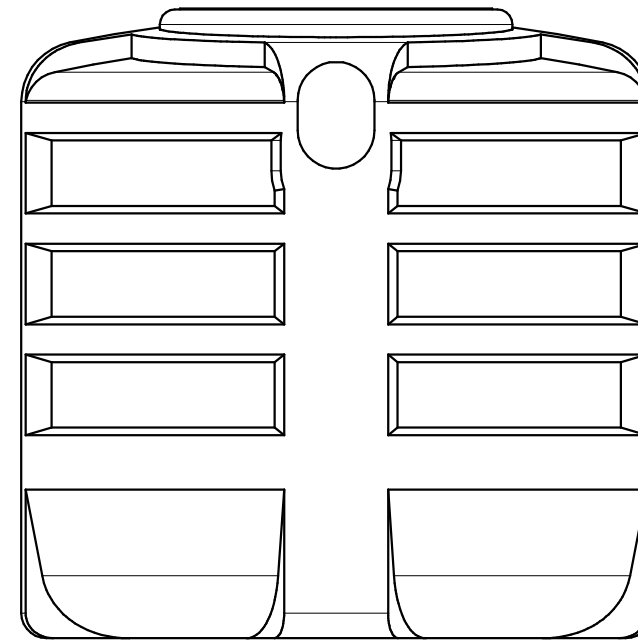
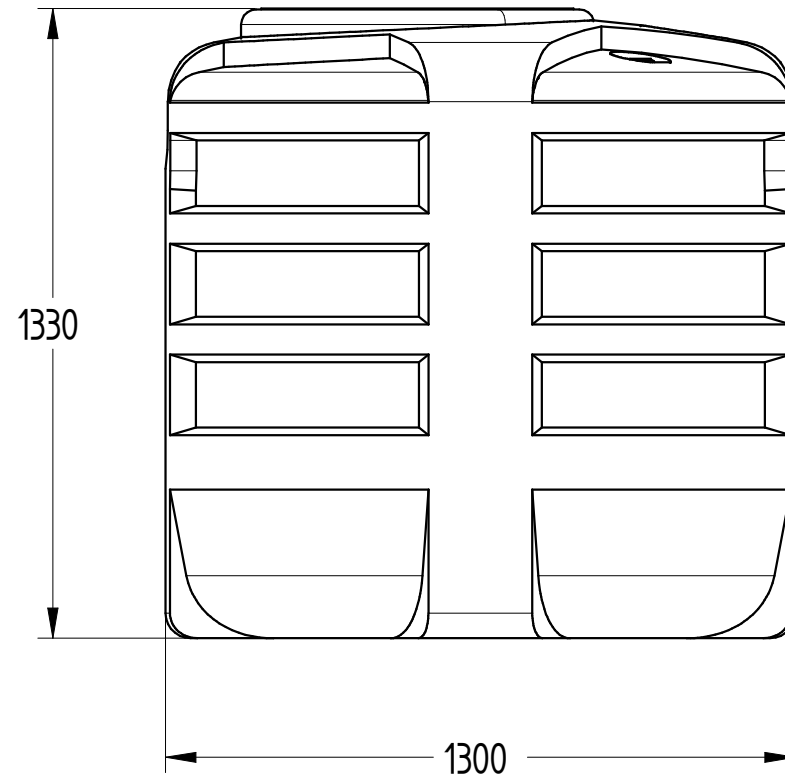

DISEGNO TECNICO

REVISIONE	NOME	DATA	MATERIALE	PESO	SCALA
Disegnato	N. Grassi	25/06/2018	LLDPE	45 KG	1:15
Controllato	G. Saltarelli	25/06/2018			
Approvato	P. Dell'Onite	25/06/2018			

DISTINTA COMPONENTI

Posizione	Descrizione	Quantità
1	Serbatoio da interro il LLDPE	1
2	Tappo ø400 a baionetta	1
3	Sfiato	1

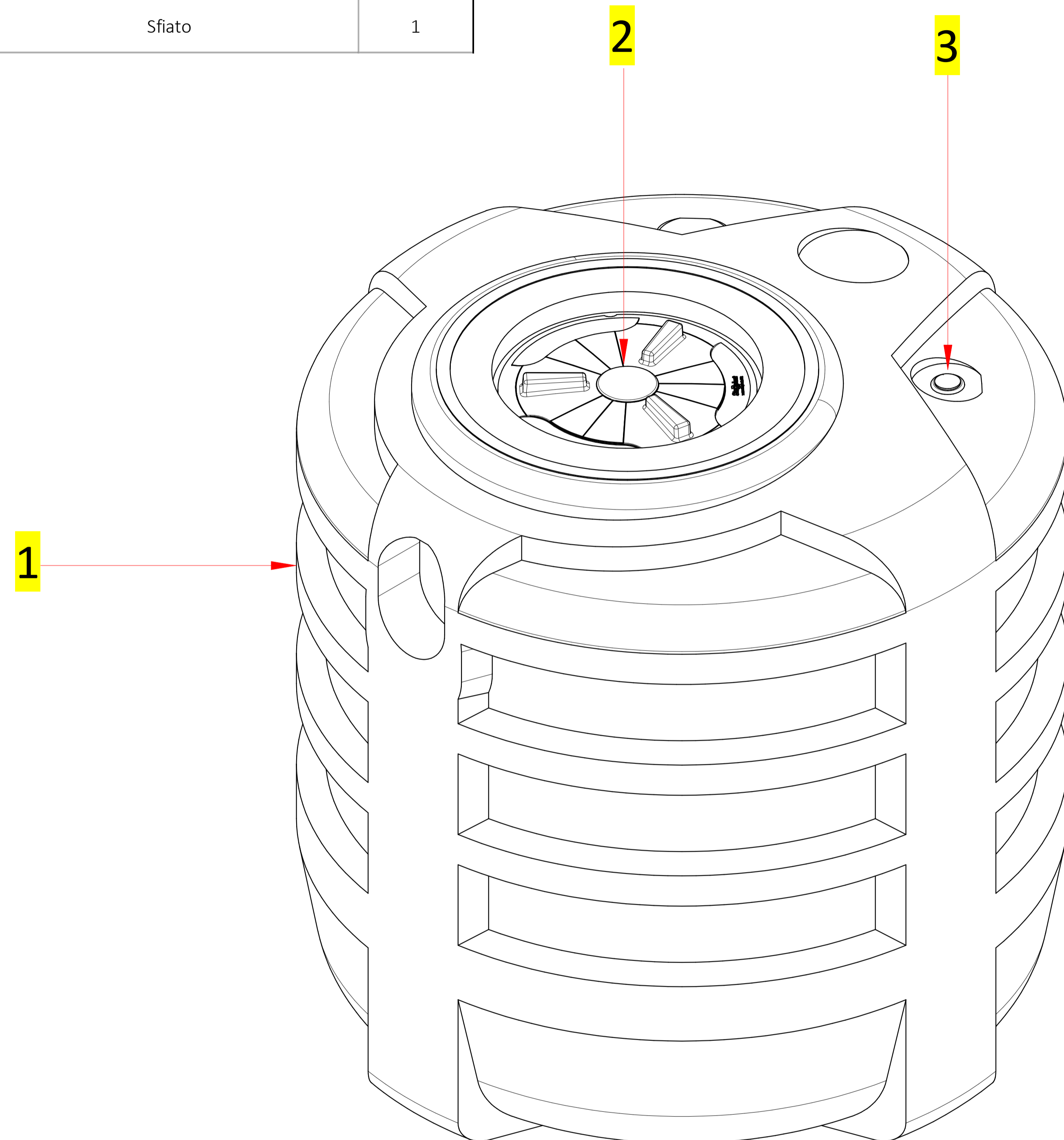

DISTINTA ACCESSORI

Posizione	Descrizione	Quantità
1	Raccordo Passaparete MASCHIO 3\4" - 1" - 1 1\4" - 1 1\2" - 2"	**
2	Guarnizione a labbro	**
3	Tubazione in PVC	**
4	CHIUSINO TELESCOPICO "CHI Y 600-400"	1
5	PROLUNGA "PRO X 400"	1

