

Codice: IMF MM 7500

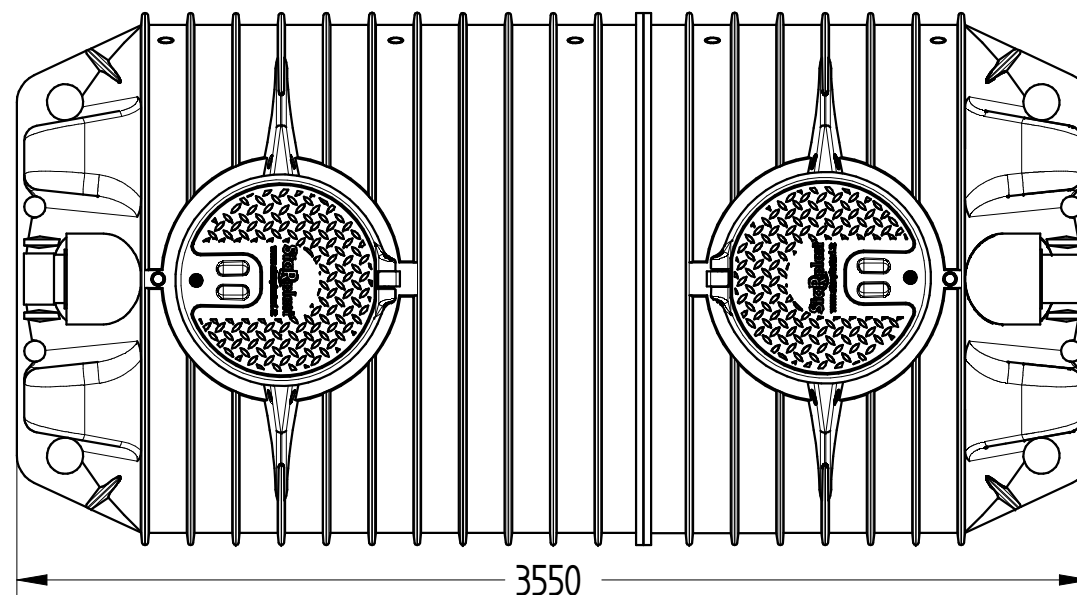
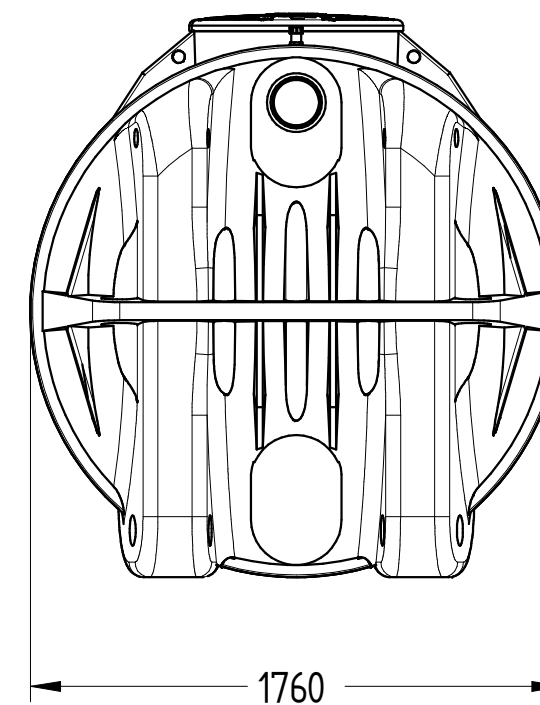
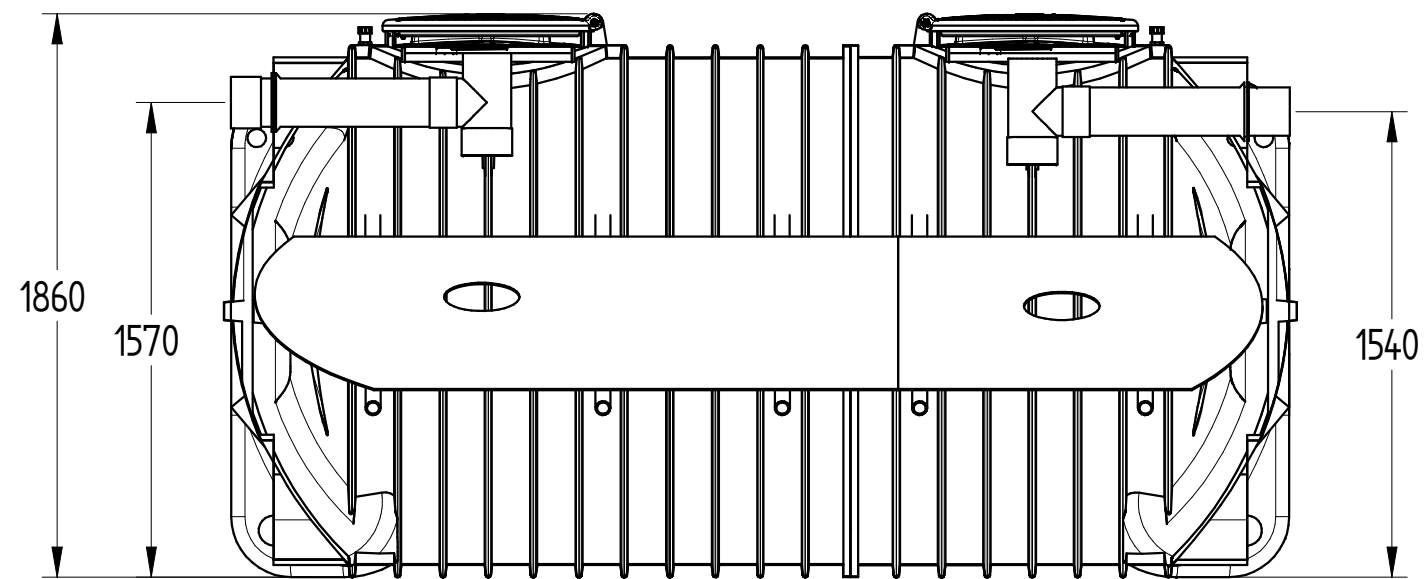

DISEGNO TECNICO

REVISIONE : 01	NOME	DATA	MATERIALE	PESO	SCALA
Disegnato	N. Grassi	28/12/2017	LLDPE	322 kg	1:25
Controllato	G. Saltarelli	28/12/2017			
Approvato	P. Dell'Onite	28/12/2017			

DISTINTA COMPONENTI		
Posizione	Descrizione	Quantità
1	Serbatoio modulare in rotazionale LLDPE	1
2	Tappo a ribalta Ø750 con chiusura a pressione	2
3	Tappo a baionetta Ø 620	2
4	Sfiato	2
5	Guarnizione a labbro	2
6	Tronchetto in PVC entrata Ø160	1
7	Tronchetto in PVC uscita Ø 160	1
8	Sedimentatore	1

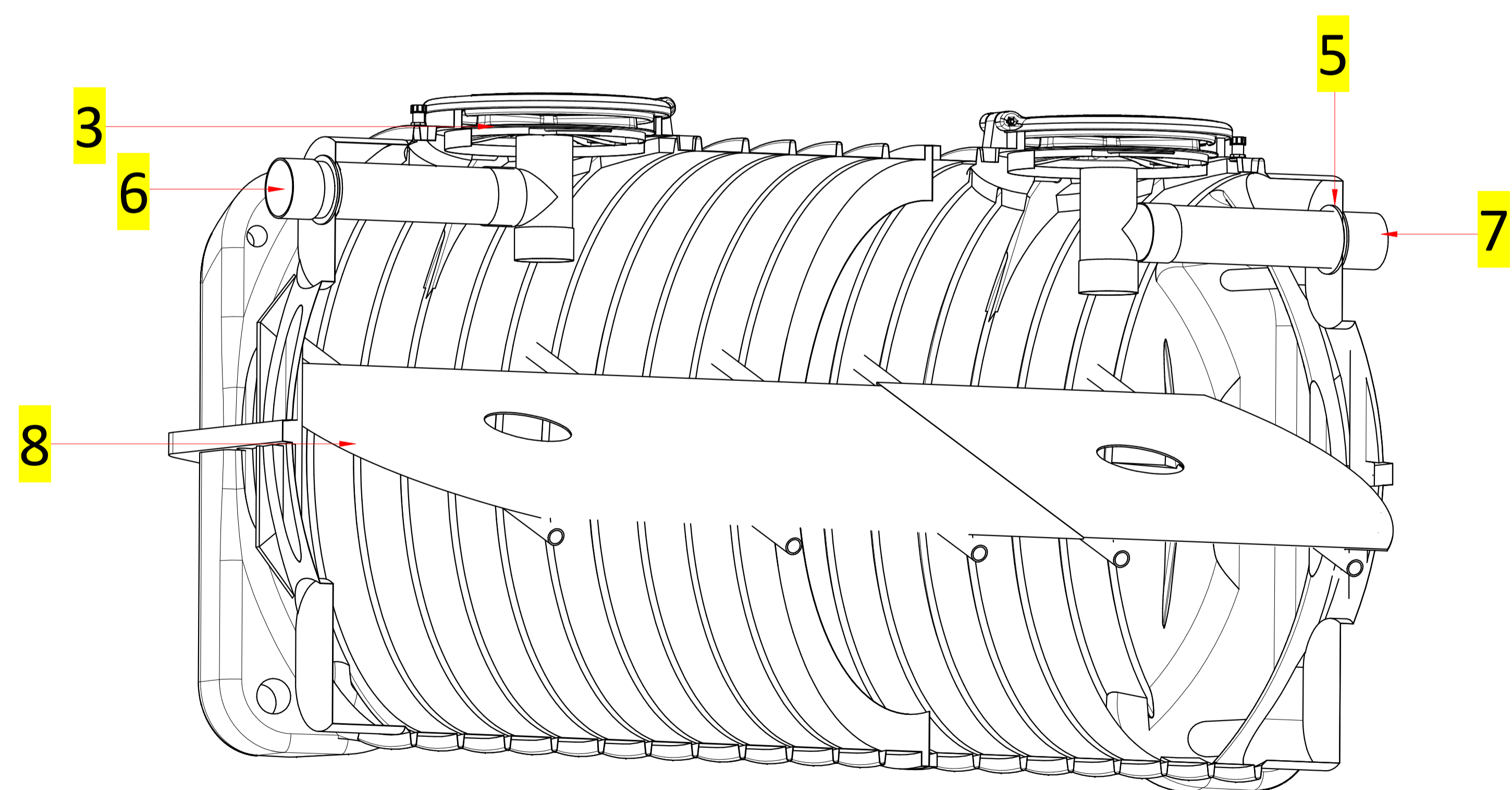
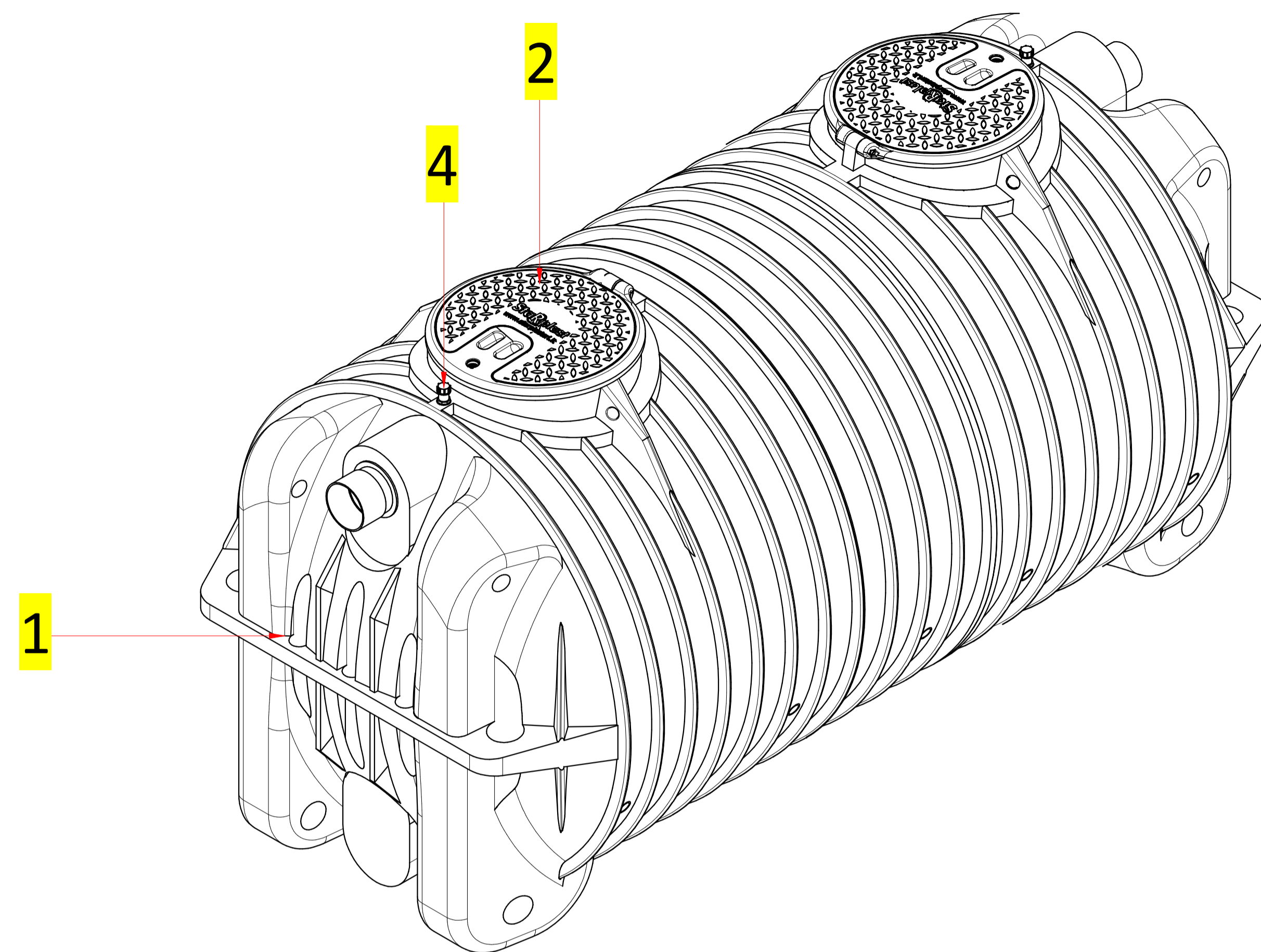

DISTINTA COMPONENTI		
Posizione	Descrizione	Quantità
1	Chiusino telescopico "CHI Y 800-600"	2
2	Prolunga "PRO X 600"	2
3	Grata antintrusione zincata	2

